

Webinar
Wednesday, June 14, 2:00PM ET/11:00AM PT

5G



Connect Beyond Boundaries

Introducing the Cloud-Managed 5G Outdoor Unit

[Register Now](#)



Kenneth Hunter
VP of Sales, Americas



Godwin Wey
Product Manager



01

Target Market

02

InODU Product Overview

03

InODU Product Features / Applications

04

Part Numbers & What to Expect

01 Target Market

1. Small and medium-sized businesses (SMBs) : Retail stores, Fast-food chains
2. SOHO where needs 5G connectivity



3 Problems Facing by Chain Stores



Cashier System



Self-service Settlement Terminal



Retail Monitor



Self-service Purchasing Terminal



Digital Signage

1 Rapid deployment of store Network

- The deployment of stores needs to be simpler and more convenient.
- A fast and efficient network is necessary as businesses and stores increases.
- The cycle of wired broadband is long, cost is high, and the fault recovery cycle is long.
- No professional network maintenance engineer.
- The network needs to be managed integrally by IT department.

2 Multi-terminal Networking

- The demand for network access is gradually increasing as there are more and more devices: POS, self-service terminal, video camera, IP phone, etc.
- Provide high quality network service for staff and customers.

3 Stable and reliable Network

- Stable and reliable network is crucial for key transaction settlement.
- Stable network can bring good experience for customer.
- Any network accident can cause sustained revenue losses for stores.

3 Problems Facing by Enterprise Branches

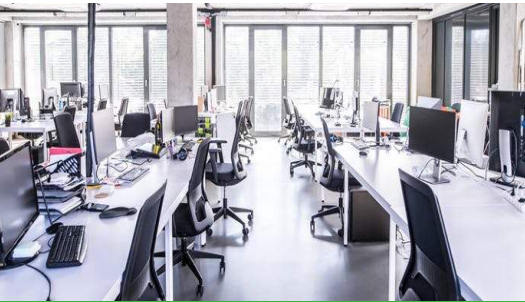

Increasing Offices



Document Transfer in Private Network



Access Internal Business System



Access Public Internet



Multi person video conferencing

1 Convenient corporate office network

- How to quickly own a network for enterprise branch points
- If you have an office network in an area that cannot be covered by wired networks
- Flexible networking, ultra wide stability, convenient management, and remote access have become urgent needs for office networks.

2 Increasing Business Application











- In remote office, members office instant messaging, high-definition video meeting, and high-capacity file transfer all rely on high-quality network environment.
- To enhance flexibility, enterprises are migrating more and more workloads to various private and public cloud resources which make the network more complex.

3 More Network Access Requirement

- Employees' requirements for network access does not decrease although network environments become more complex.
- On the contrary, to prevent the loss of face-to-face communication opportunities in remote office, employee collaboration requires a higher level of network access experience.
- Any unexpected network interruption can lead to a decrease in group efficiency.

InODU Product Overview

IoT/M2M Products

 <p>Enterprise / IT</p>	<p>"Cloud + Edge" IoT Solution</p>	 <p>Edge Router</p>	 <p>Outdoor Unit</p>
 <p>Developer</p>	<p>Full OS / Programming Environment</p>	 <p>IoT Edge Gateway</p>	 <p>Industrial Computer</p>
 <p>Router/Vehicle</p>	<p>IIOT/M2M</p>	 <p>Industrial Cellular Router</p>	 <p>Vehicle Gateway</p>
 <p>Connectivity</p>	<p>Portable / FWA Routers</p>	 <p>Cellular Router</p>	

InCloud Manager

Visual Unified Management

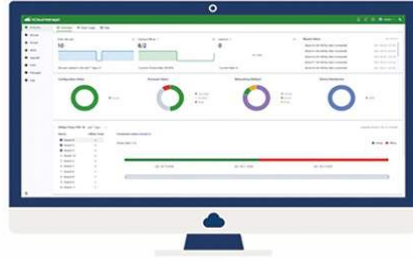

Full Lifecycle Management



Network Visibility



Application Insight

Store Branch Networking

- 4G/5G Cellular Networking
- Link Failure Transfer
- High-Performance
- Network Fault Diagnosis
- Zero-Touch Deployment
- Centralized Cloud Management

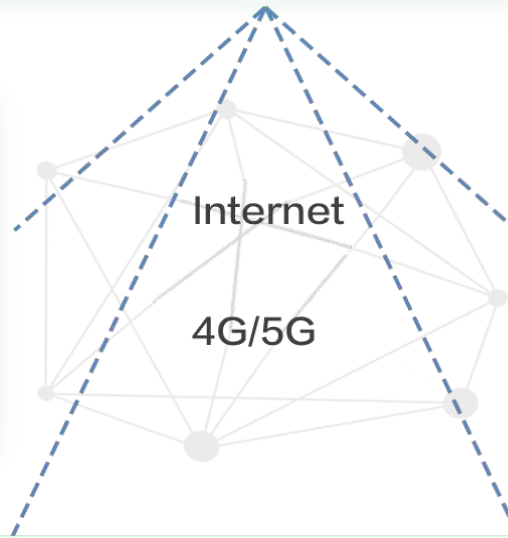

Enterprise Office Networking

- SD-WAN
- Traffic & Application Analysis
- Network Visualization
- Intelligent NetOps
- Network Security
- Unified Cloud Management



Network Hardware



5G ODU



Cost-Effective Router ER605



High Performance Router ER805



Gigabit Router ER1000



High Performance Wi-Fi 6 AP



Cloud-Managed Switch



5G FWA

High Reliable 5G Outdoor Unit with Cloud Management



High-performance 5G/4G Cellular

DL : 4.76Gbps, UL : 1.25Gbps



Firewall Throughput: 2Gbps
Clients: 200



2.5G Ethernet

WAN/LAN, PoE



Security

Firewall, anti-Dos, ACL

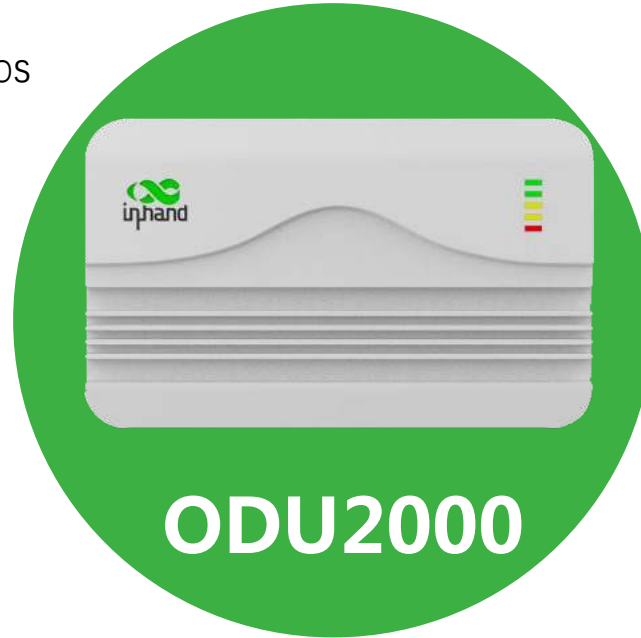

Omni Antenna



6 external 5G fiberglass antennas,
TNC waterproof interface

Adapt to Harsh Outdoor Environment



IP67, -30 ~ 70C°, Aluminum housing, GPS

Wall & pole mounted



Adjustable installation angle

Cloud deployment and management

Complete, simple cloud management



■ Dimensions (mm)

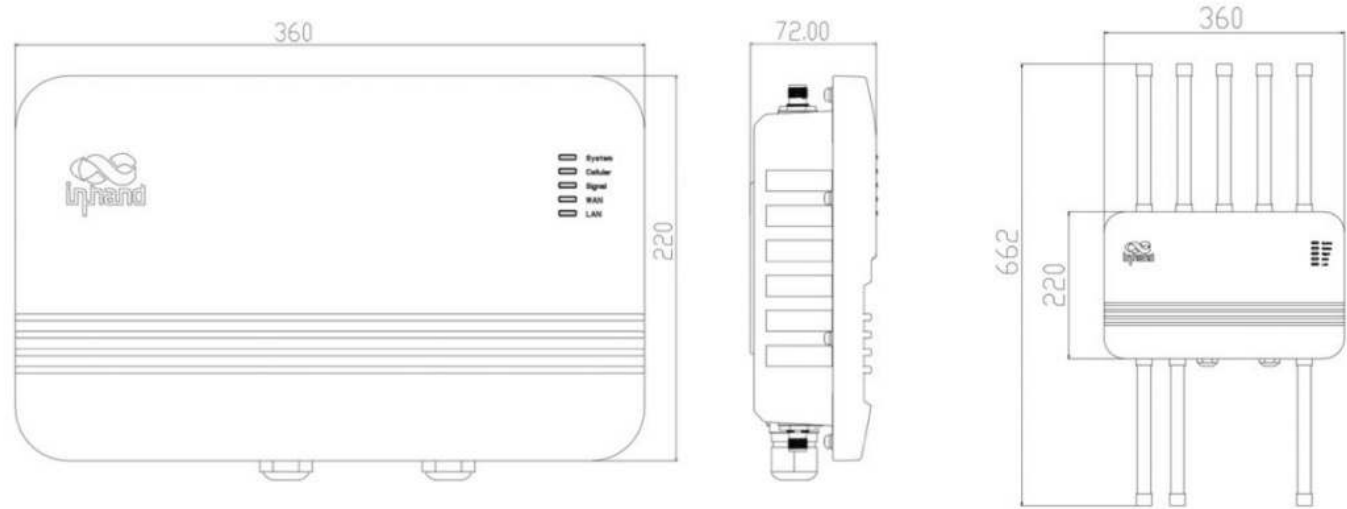



ER805 (5G Edge Router)

- Application scenario: Enterprise branch networking
- Cloud platform : InCloud
- Firewall Throughput : 600Mbps
- Recommended Users : 100-150
- 5G Sub-6 : DL:2Gbps, UL:200Mbps
- eSIM : NO
- Ethernet : 5*1000Mbps, WAN/LAN
- Wi-Fi : 802.11 ac/b/g/n, 1200Mbps
- GPS : NO
- IP30
- Temperature: -20 ~ 70C°/ -40 ~ 85C°
- Rich network functions : SD-WAN, VxLAN
- Price : 999 \$

5G ODU (5G Outdoor Unit)

- Application scenario: Enterprise branch networking
- Cloud platform : InCloud
- Firewall Throughput : Up to 2Gbps
- Recommended Users :200
- 5G Sub-6 : DL:4.76Gbps, UL:1.25Gbps
- eSIM : YES
- Ethernet : 2*2.5Gbps, WAN/LAN (PoE)
- Wi-Fi : 802.11 b/g/n, 150Mbps
- GPS : YES
- IP67, Outdoor environment
- Temperature: -30 ~ 70C°/ -40 ~ 85C°
- Simple network functions
- Price : 1199 \$



InODU Product Features

Unleash the Power of 5G

Leveraging high-performance and fast 5G cellular network access, InHand 5G ODU delivers excellent connectivity with low latency, fully unlocking the potential of 5G

- Ultra-fast 5G network, DL: 4.76Gbps, UL: 1.25Gbps
- SA/NSA networking
- 5G Sub-6 GHz, C band
- Compatible with LTE CAT19

Agility and Robustness



With outstanding performance, InHand 5G ODU helps enterprises build more robust and agile networks, facilitating business growth with improved experience.

- Throughput up to 2Gbps
- 2*2.5Gbps Ethernet port
- WAN/LAN or dual LAN
- PoE-enabled LAN port

Purposely Designed for Outdoors

Committed to rigorous design principles, the InHand 5G ODU exemplifies meticulous attention to detail. From product design to component selection, every aspect is carefully crafted, ensuring exceptional performance even in harsh outdoor environments.



- IP67 protection rating
- Die-cast aluminum metal housing, fanless design
- Operating temperature: -30~70°C
- Flexible wall/pole mounting with adjustable angles
- External 6 high-performance 5G antennas made of fiberglass
- High-precision GPS location tracking

Worry-free Connectivity

The ODU2000 offers “always-online” connectivity, ensuring network stability, minimizing your risk of network failure.

- Wired/cellular failover, redundancy
- Dual NANO SIM for different carriers
- Optional eSIM with external SIM link redundancy
- Multi-layer link detection, auto recovery from faults

Always
Online

Zero-touch Deployment

Zero-touch deployment streamlines the process effortlessly. Non-IT individuals can easily power and install on-site network equipment, while IT professionals remotely configure and troubleshoot devices from the cloud, reducing deployment costs.

- Plug & play
- App configuration
- Web configuration
- Configuration via InCloud Manager

Efficiently Managed in the Cloud

The InHand 5G ODU, paired with the InCloud Manager, enables seamless cloud management of distributed sites at scale. Gain real-time network monitoring and enhance IT management efficiency from anywhere, breaking free from limitations.

- Unified management access platform
- Simple and intuitive graphical data
- Easy-to-use management interface
- Overview of business

 InCloud Manager

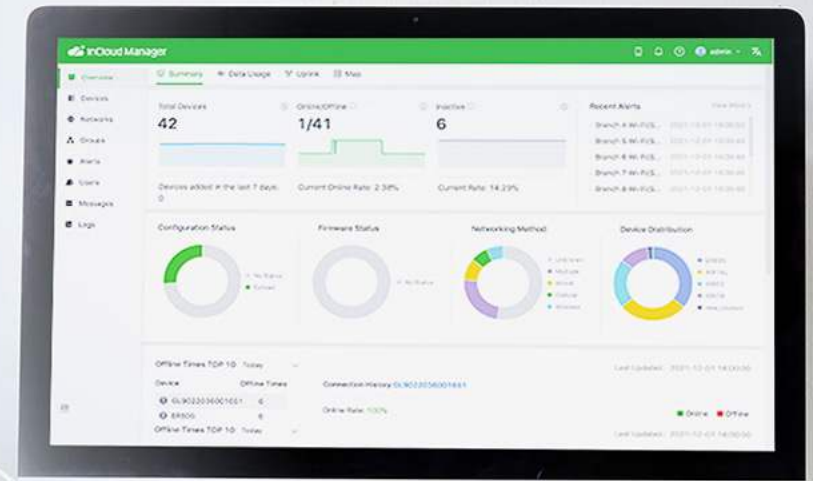

Business Control with Mobile APP

InCloud Manager provides the possibility to remotely control business anytime and anywhere, making management seamlessly connected.

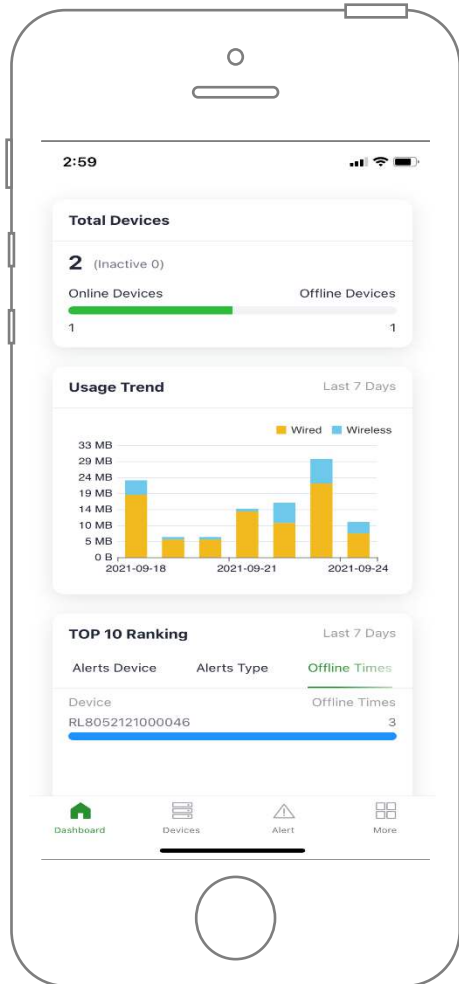

Config. & Networking
via QR code scanning



Supports configuration of Wi-Fi connected devices to the cloud via QR code scanning

Interface dataflow
monitoring



Monitors interface status through visualized interfaces, remotely monitors security status of devices

Alarm fault diagnosis



Supports a variety of alarm strategies, device diagnostic tools and remote control commands, quickly locates and solves problems

Multi-dimensional
data analysis



Full-service Dashboard, overview of device growth, status distribution, traffic trend analysis, alarm status rankings, etc. Insights into networks & devices

Easy management



Monitors and manages your networks and devices anytime, anywhere, as long as you can access the Internet

Applications

Main application scenarios

Chain and Branch Network

- Convenience Store
- Fast food restaurants
- Clothing chain stores
- Retail chain
- Cosmetic chain stores
- Pharmacy
- New style tea drink chain store
- Chain Hotel
- Unmanned Supermarket

Enterprise Office Network

- Small enterprise office network
- small and medium-sized branches
- SOHO Office
- Education and training institutions
- Financial branch outlets
- Government

Provide 'Always-On-Line' Network Service for Branches

Provide High Quality Network Service for Enterprise Office

Under the impact of pandemic, mixed office has become common in enterprises. Although the network environment has become complex, employees' requirements for network access does not decreased. Need to provide efficient and stable network to improve the efficiency of enterprise office

Network requirement :

- Cellular backup for stable network connection
- Bandwidth upgrade and network expansion
- Shorten network deployment cycle
- Unified and centralized management

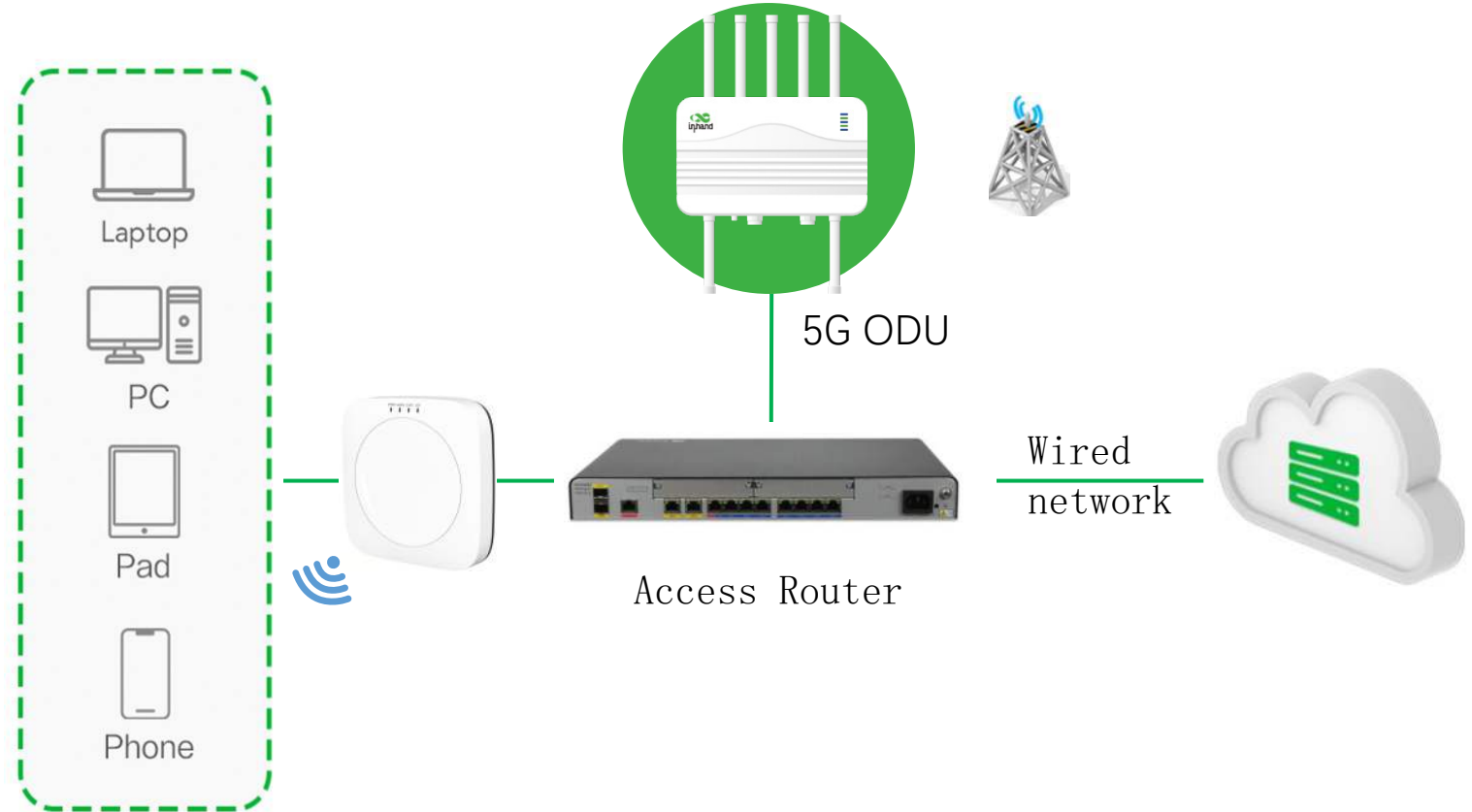

- Provide redundant link for crucial business
- High speed 5G, 2Gbps throughput
- Cellular backup
- Efficient cloud management

Network Solution for Branch

The number of chain stores will rapidly expand with the rapid development of the enterprise, and the IT team needs to quickly complete the network deployment of many stores in a short period of time

Network requirement :

- Convenient network in new branches
- More Reliable network for settlement service
- Always-on-line network

Provide convenient 5G network for chain branches

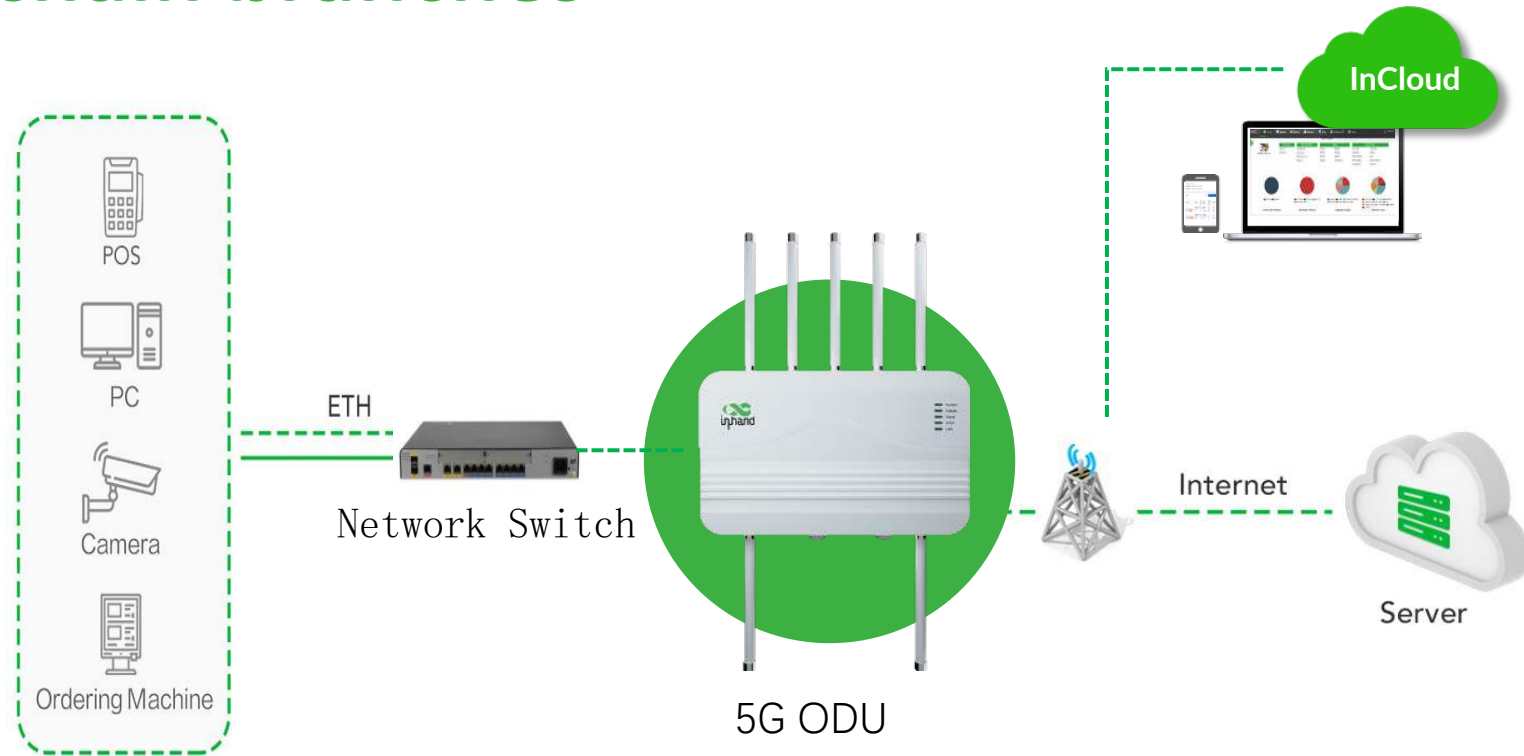

- Convenient and high speed 5G cellular
- Simple deployment and debug
- APP/Cloud management
- Adapt to Harsh Outdoor Environment

Quickly building an efficient enterprise network

Quickly building an efficient enterprise network

How to quickly build an efficient network for enterprise branches, so that enterprises can more efficiently invest in business development. No need to wait for the deployment cycle of wired broadband networks, reduce enterprise network investment costs, and obtain high-speed networks.

Network requirement :

- Quickly building a network
- Shorten deployment cycle
- High bandwidth and high-speed network, ensuring smooth office network for enterprises

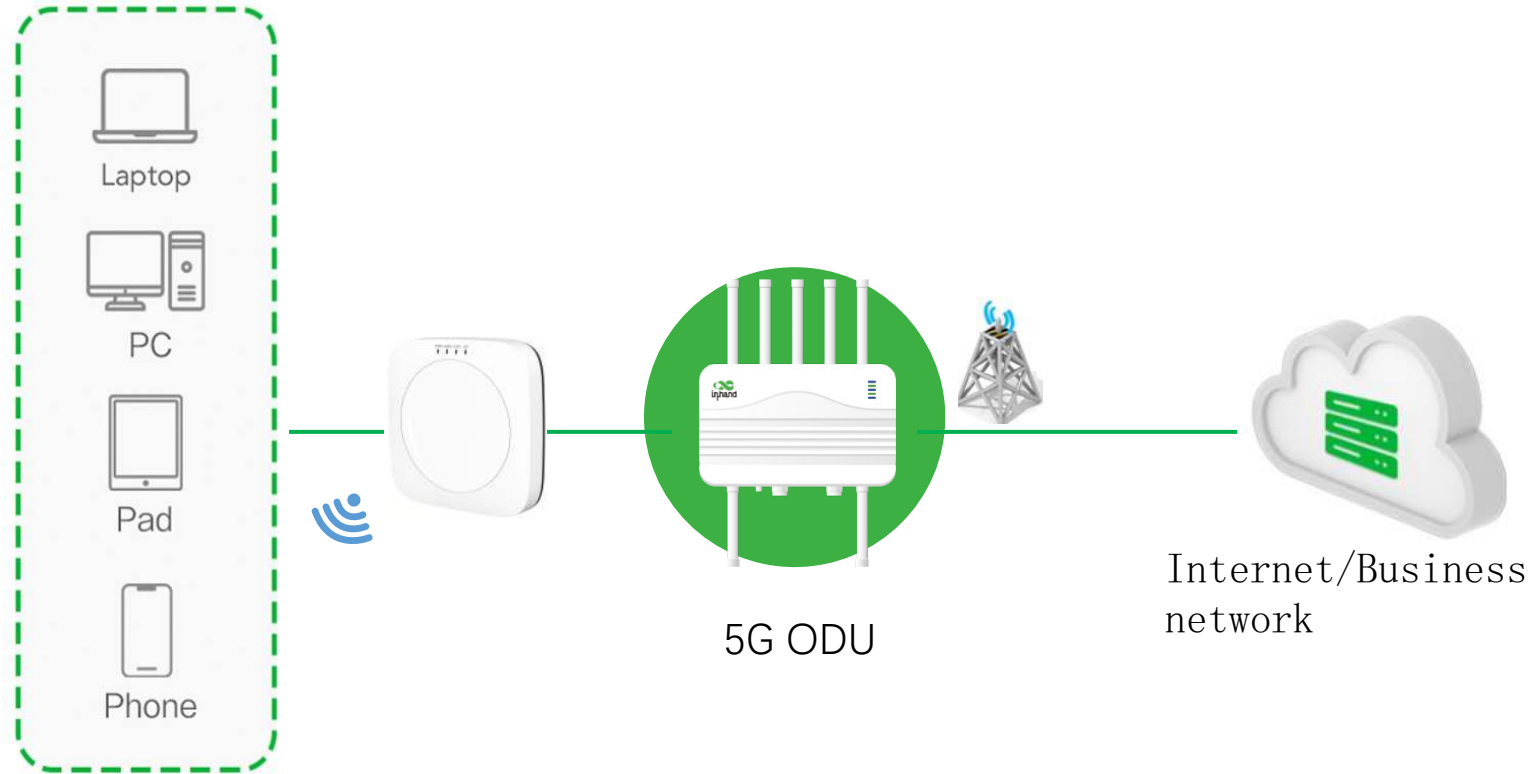

- High speed 5G, convenient network access
- 2Gbps throughput, Enhance the online experience
- Adapt to harsh outdoor environments

Provide convenient 5G network for chain branches

Chain Branch High Reliable Networking Solution

Chain enterprises have a large number of business branches and outlets, and daily network management has become a key task. Interruption of store business network can affect business transactions, cause losses in corporate profits, and even affect customers' shopping experience.

Network requirement :

- The original network architecture of the chain branch points remains unchanged
- Need a reliable network
- Does not affect settlement business
- Provide uninterrupted network

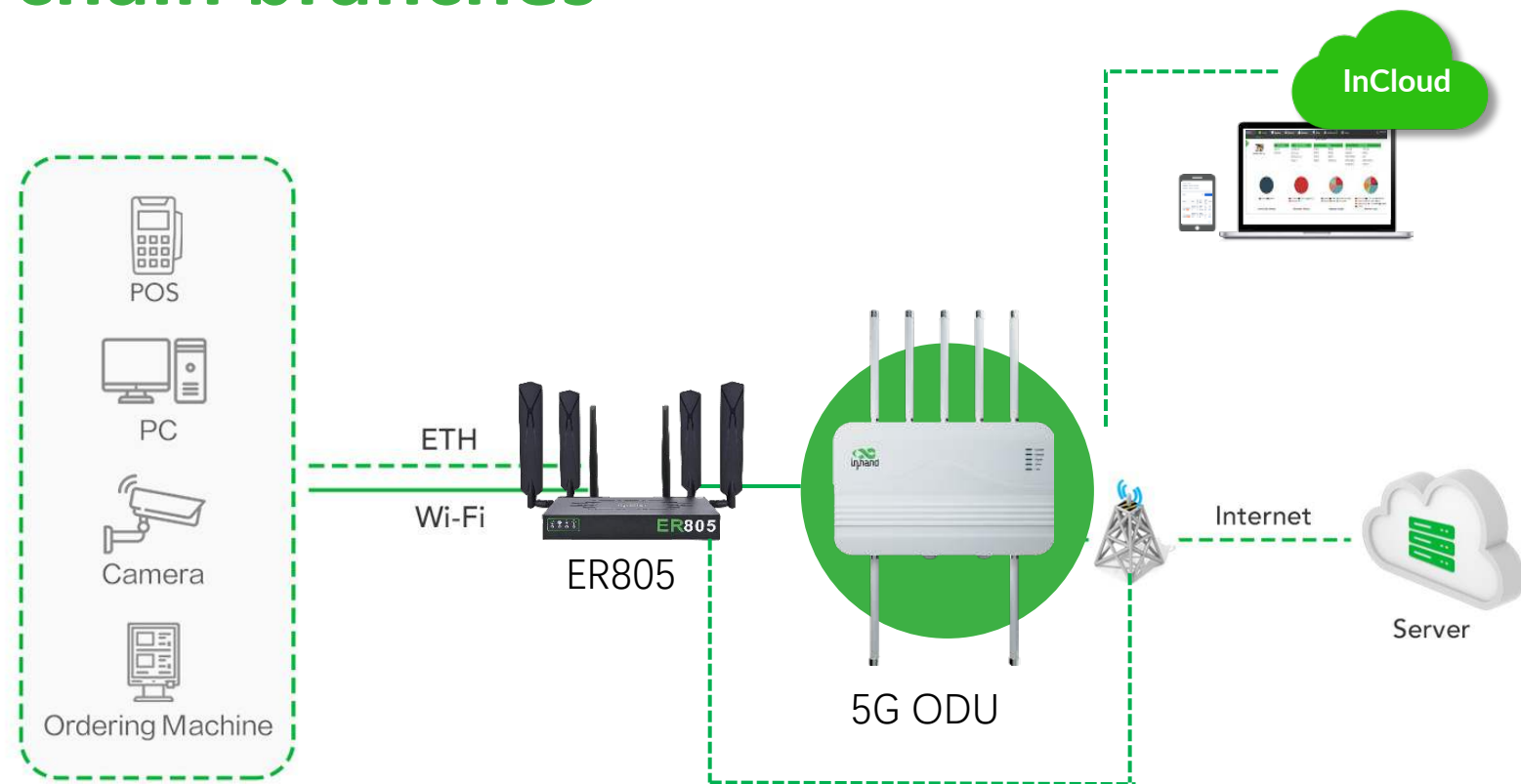

- 5G high-speed network
- Link Failover / 2 Cellular WANs
- Cloud Management
- Adapt to harsh outdoor environments

Part Numbers & What to Expect

Product Order info

Model	Code	Network	Bands
ODU2002-NAVA (available)	GPRO39001	Verizon and AT&T	(For North America, Verizon, ATT) 5G Sub-6: n2/5/7/12/14/25/30/41/48/66/71/77/78 LTE-FDD: B2/4/5/7/12/13/14/17/25/26/29/30/66/71 LTE-TDD: B41/46/48 WCDMA: B2/4/5
ODU2002-NATM (Samples estimated in JUL 2023)	GPRO390007	T-Mobile	(For North America, T-Mobile) 5G SUB6 n25/41/66/71 LTE FDD: B2/4/5/12/66/71 LTE TDD: 41 LAA: B46
ODU2002-EUNR (Will be aval. in AUG 2023)	GPRO390008		(For Europe/Australia/Asia) 5G SUB6 n1/3/5/7/8/20/28/38/40/41/71/77/78/79 LTE FDD: B1/3/5/7/8/20/28/32/71 LTE TDD: B38/40/41/42/43

Product Accessories

Part Code	Part Name	Qty.	ODU-50feet kit Code: VPAK390001	ODU-100feet kit Code: VPAK390002	ODU-200feet kit Code: VPAK390003
AANT110009	5G Antenna	2			
AANT110010	5G MIMO Antenna	4	Ethernet Surge Protector	Ethernet Surge Protector	Ethernet Surge Protector
AANT060026	Wi-Fi Antenna	1	Grounding Wire 50ft	Grounding Wire 100ft	Grounding Wire 200ft
AANT040018	GNSS Antenna	1	Cat 6 shielded F/UTP 50ft	Cat 6 shielded F/UTP 200ft	Cat 6 shielded F/UTP 200ft
AETH020001	Ethernet Cable	1	Copper Offset lug	Copper Offset lug	Copper Offset lug
APWR030005	PoE Adapter	1	Mechanical Lug	Mechanical Lug	Mechanical Lug
APWR020022	AC cord	1			
SSSM390002	Mounting Bracket	1	Outdoor zip ties (12", 20 PCS)	Outdoor zip ties (12", 20 PCS)	Outdoor zip ties (12", 20 PCS)
SSSM390003	Mounting plate	1	RJ45 connector (10 pcs)	RJ45 connector (10 pcs)	RJ45 connector (10 pcs)
	Pole mount bracket	1			

Standard accessories
Come with ODU2002

Optional accessories

Product installation method

5G ODU2002

Mount options

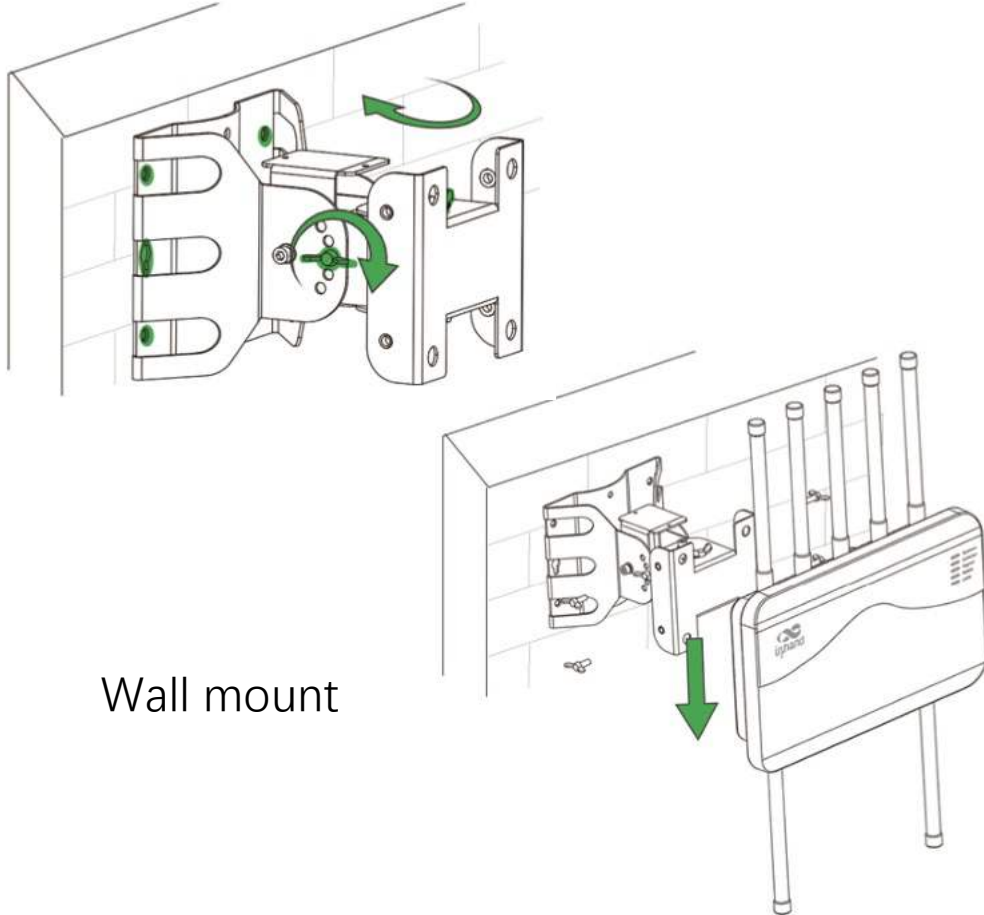

Wall mount

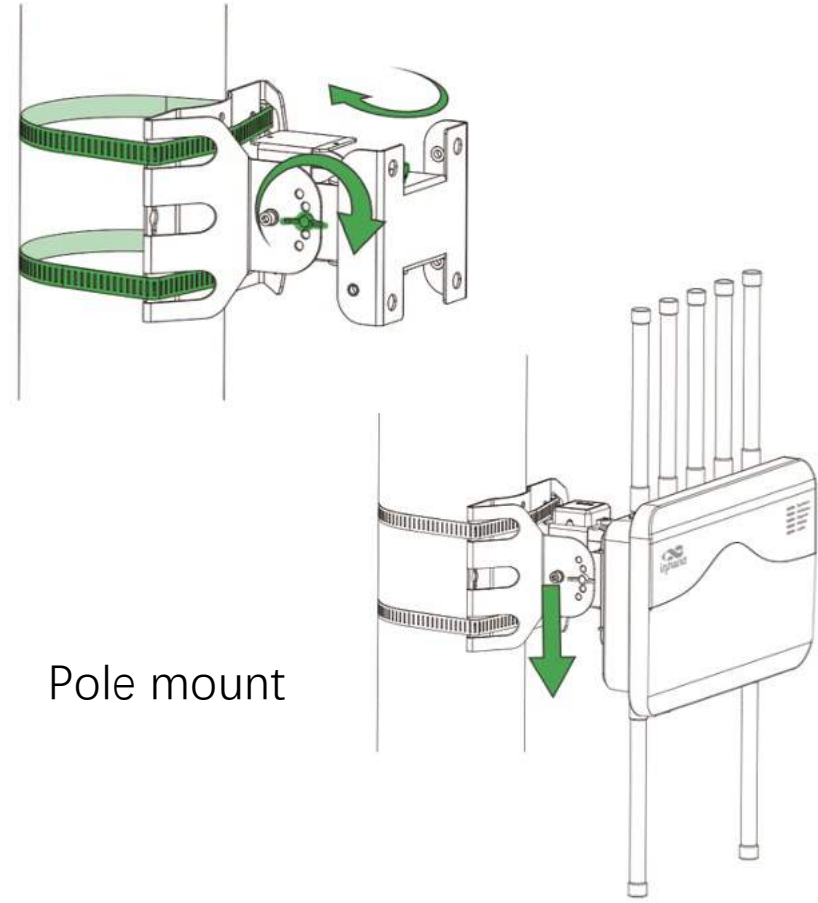

Pole mount

Product packaging instructions

5G ODU2002

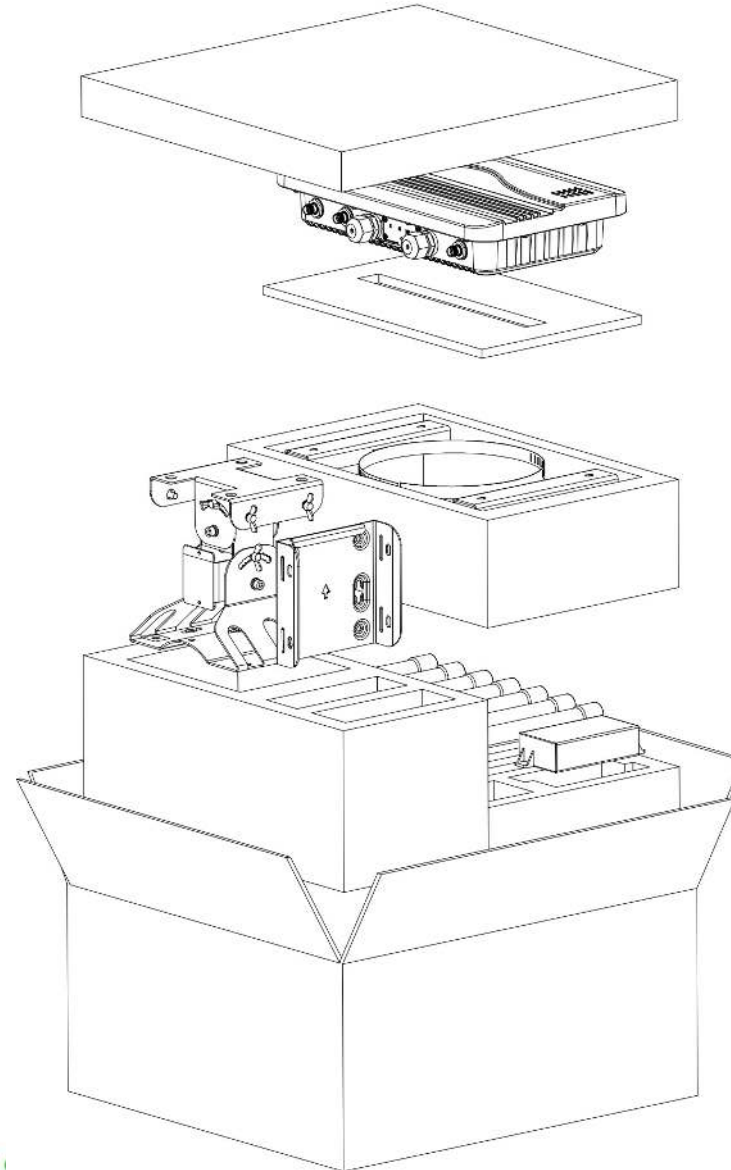
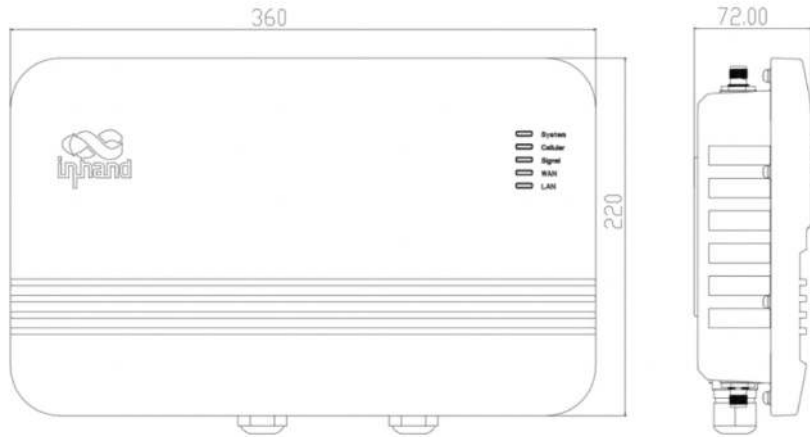



InHand Networks

A Global Leader in Industrial IoT

43671 Trade Center Place, Suite 100,
Dulles, VA 20166
+1 (703) 348 2988